



## AKZ1110/..FS-5.08-GREEN

## Technical Data

| Wire Sizes                |                      | Insulating Material                |                 |
|---------------------------|----------------------|------------------------------------|-----------------|
| Solid min                 | 0.2 mm <sup>2</sup>  | Material                           | PA 6.6          |
| Solid max                 | 4.0 mm <sup>2</sup>  | Flammability Class                 | UL 94 V-0       |
| Stranded (flexible) min   |                      | <b>Temperatures</b>                |                 |
| Stranded (flexible) max   | 0.2 mm <sup>2</sup>  | Operating Temperature              | -30 °C - 105 °C |
| Stranded with Ferrule min |                      | <b>Wave Soldering Process</b>      |                 |
| Stranded with Ferrule max | 0.25 mm <sup>2</sup> | Soldering Temperature, recommended | -               |
| Stranded with Ferrule max |                      | Peak Soldering Time, recommended   | -               |
| <b>Dimensions</b>         |                      | <b>Reflow Process</b>              |                 |
| Stripped Length           | 7.0 mm               | Soldering Temperature, recommended | -               |
| PCB Hole Diameter         | -                    | Peak Soldering Time, recommended   | -               |
| <b>Materials</b>          |                      |                                    |                 |
| Clamp                     | Brass                |                                    |                 |
| Screw                     | Steel                |                                    |                 |
| Contact Spring            | Bronze               |                                    |                 |

## Colours

 GREEN, RAL 6018  LIGHT GREEN, similar RAL 6018

Colours according to RAL, there may be variations on colour due to production conditions. Special colours on request.

## Counterparts (Spacing 5.08 mm)

Pin Strip / Terminal Block



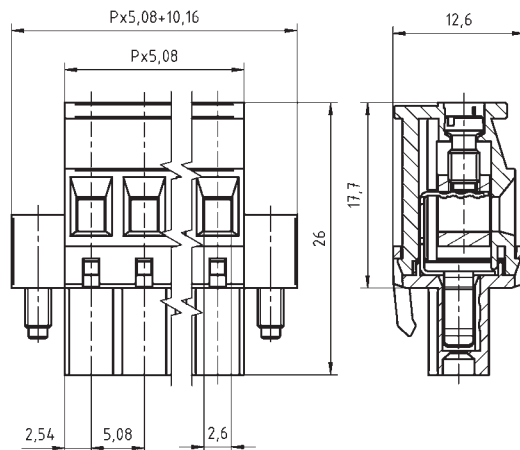



STLZ950 STLZ970 STLZ990 AKZ950 AKZS950



## Order Data (Spacing 5.08 mm)

| Poles | Width (mm) | Article Designation     | Article Number | PU  |
|-------|------------|-------------------------|----------------|-----|
| 2     | 20.32      | AKZ1110/2FS-5.08-GREEN  | 51110022001F   | 200 |
| 3     | 25.40      | AKZ1110/3FS-5.08-GREEN  | 51110032001F   | 200 |
| 4     | 30.48      | AKZ1110/4FS-5.08-GREEN  | 51110042001E   | 100 |
| 5     | 35.56      | AKZ1110/5FS-5.08-GREEN  | 51110052001E   | 100 |
| 6     | 40.64      | AKZ1110/6FS-5.08-GREEN  | 51110062001E   | 100 |
| 7     | 45.72      | AKZ1110/7FS-5.08-GREEN  | 51110072001E   | 100 |
| 8     | 50.80      | AKZ1110/8FS-5.08-GREEN  | 51110082001E   | 100 |
| 9     | 55.88      | AKZ1110/9FS-5.08-GREEN  | 51110092001D   | 50  |
| 10    | 60.96      | AKZ1110/10FS-5.08-GREEN | 51110102001D   | 50  |
| 11    | 66.04      | AKZ1110/11FS-5.08-GREEN | 51110112001D   | 50  |
| 12    | 71.12      | AKZ1110/12FS-5.08-GREEN | 51110122001D   | 50  |
| 13    | 76.20      | AKZ1110/13FS-5.08-GREEN | 51110132001D   | 50  |
| 14    | 81.28      | AKZ1110/14FS-5.08-GREEN | 51110142001D   | 50  |
| 15    | 86.36      | AKZ1110/15FS-5.08-GREEN | 51110152001D   | 50  |
| 16    | 91.44      | AKZ1110/16FS-5.08-GREEN | 51110162001D   | 50  |
| 17    | 96.52      | AKZ1110/17FS-5.08-GREEN | 51110172001D   | 50  |
| 18    | 101.60     | AKZ1110/18FS-5.08-GREEN | 51110182001D   | 50  |
| 19    | 106.68     | AKZ1110/19FS-5.08-GREEN | 51110192001D   | 50  |
| 20    | 111.76     | AKZ1110/20FS-5.08-GREEN | 51110202001D   | 50  |
| 21    | 116.84     | AKZ1110/21FS-5.08-GREEN | 51110212001D   | 50  |
| 22    | 121.92     | AKZ1110/22FS-5.08-GREEN | 51110222001D   | 50  |
| 23    | 127.00     | AKZ1110/23FS-5.08-GREEN | 51110232001D   | 50  |
| 24    | 132.08     | AKZ1110/24FS-5.08-GREEN | 51110242001D   | 50  |

## Accessories

| Figure  | Designation  | Article Number |
|---|--|----------------|
|  | Bridge, 2-pole, insulated, BRI/2-5.0/5.08-LIGHT GREY | 50000000006    |
|  | Bridge, 3-pole, insulated, BRI/3-5.0/5.08-LIGHT GREY | 50000000007    |
|  | Bridge, 2-pole, BR/2-5.0/5.08-L7.0                   | 50000000008    |
|  | Coding Star CS4-5.0/5.08-RED                         | 50000000026    |
|  | Series AK(Z)1110 with separating element             | on request     |
|  | Series AK(Z)1110 with pull relief                    | on request     |

See pages 282 ff for detail and general accessories and see pages 12/13 concerning services.

## Ratings

| Usegroup             | c ALUS   |           | VDE     |           |
|----------------------|----------|-----------|---------|-----------|
|                      | B        | C         | D       |           |
| Rated Voltage        | 300 V    | -         | 300 V   | 250 V     |
| Rated Current        | 11 A     | -         | 10 A    | 10 A      |
| Overvoltage Category |          |           |         | III       |
| Rated Wire Size      |          |           | min     | max       |
|                      | solid    | AWG 28-12 | -       | AWG 28-12 |
|                      | stranded | AWG 28-12 | -       | AWG 28-12 |
| Torque               | 0.50 Nm  |           | 0.50 Nm |           |
| Screw Size           | M3       |           | M3      |           |
| Test Voltage         | 1.6 kV   |           | 1.6 kV  |           |
| Pollution Degree     | 3        |           |         |           |